

# R120101135

Lv4-2022-r2

Modelo-model:

## FIRRAK ancora kit

Lote-Lot-Lot-Lot:

**02-22**

Peso-Weight-Poids-Gewicht:

**1,40 kg**

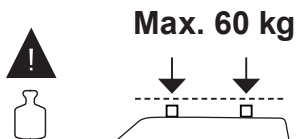

CEE - EEC type approval:

**E<sub>9</sub>** 26 R- 04 3015

ES	<b>Instrucción de montaje</b> ¡Leer primero!	Kit de fijación
EN	<b>Assembly instructions</b> Read first!	Fixation kit
FR	<b>Instruction de montage</b> Lire en premier!	Kit fixation
DE	<b>Montageanleitung</b> Zuerst lesen!	Stützfuß-Kit

1

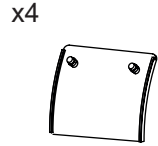
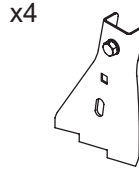
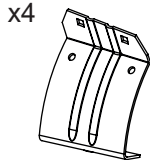
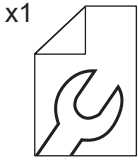

1x (1873)  
1x (1874)  
1x (1875)  
1x (1876)

(815-300)

2x (012-060)  
2x (012-070)

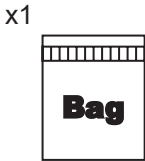

(810-045)

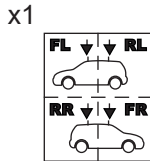

(018-041)

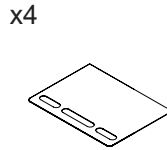

(018-098)



**Importante!**  
**Important!**  
**Important!**  
**Wichtig!**

ES ¡Este Kit de fijación tiene que usarse con sistemas portacargas FIRRAK!

EN This fixation Kit must be used with FIRRAK roof rack systems!

FR Cet Kit de fixation devra être utilisé avec les systèmes porte-charge FIRRAK!

DE Dieser Stützfuß-Kit muß mit FIRRAK Dachträgersystemen benutzt werden!

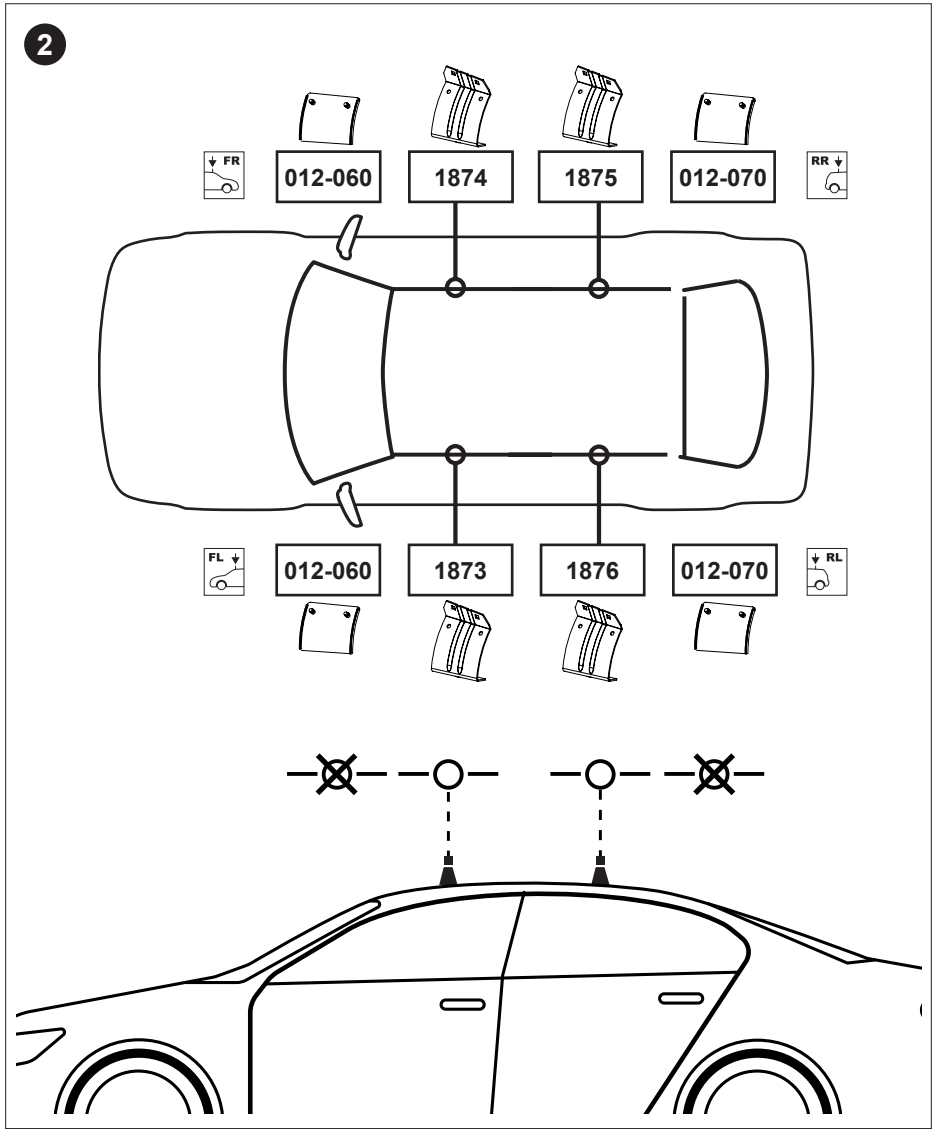

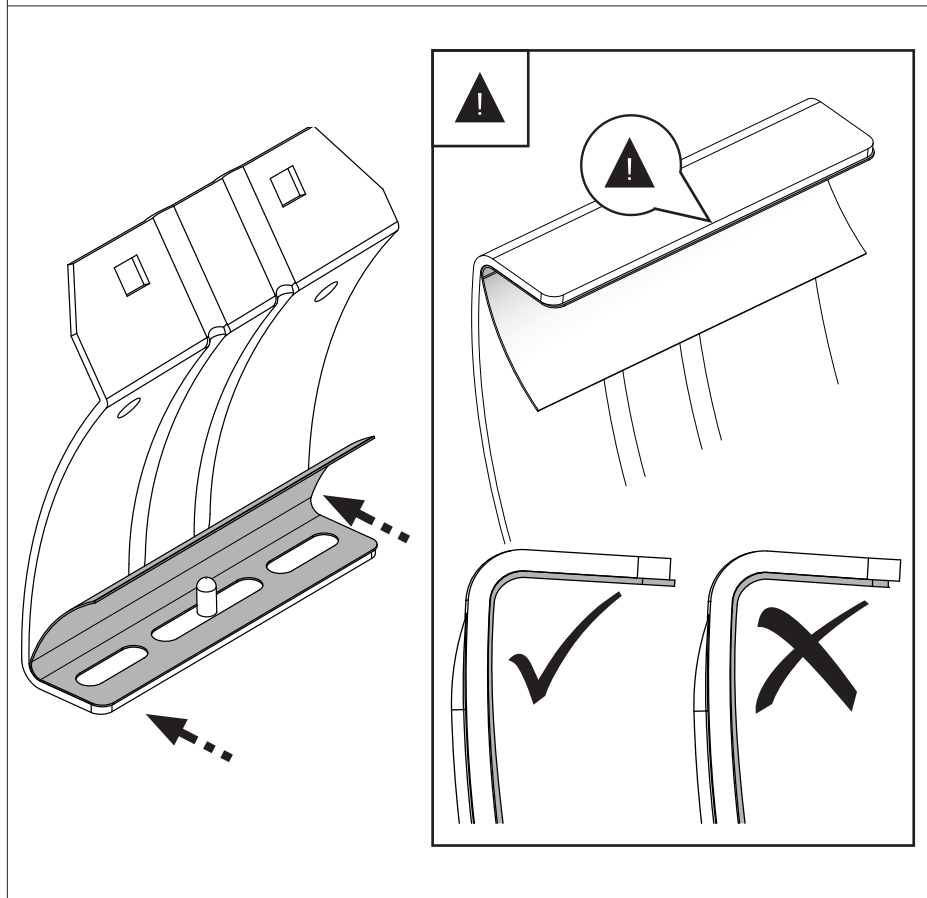
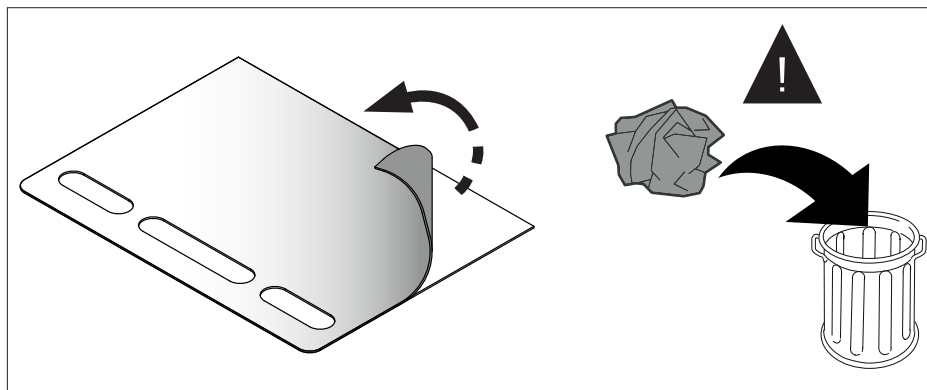

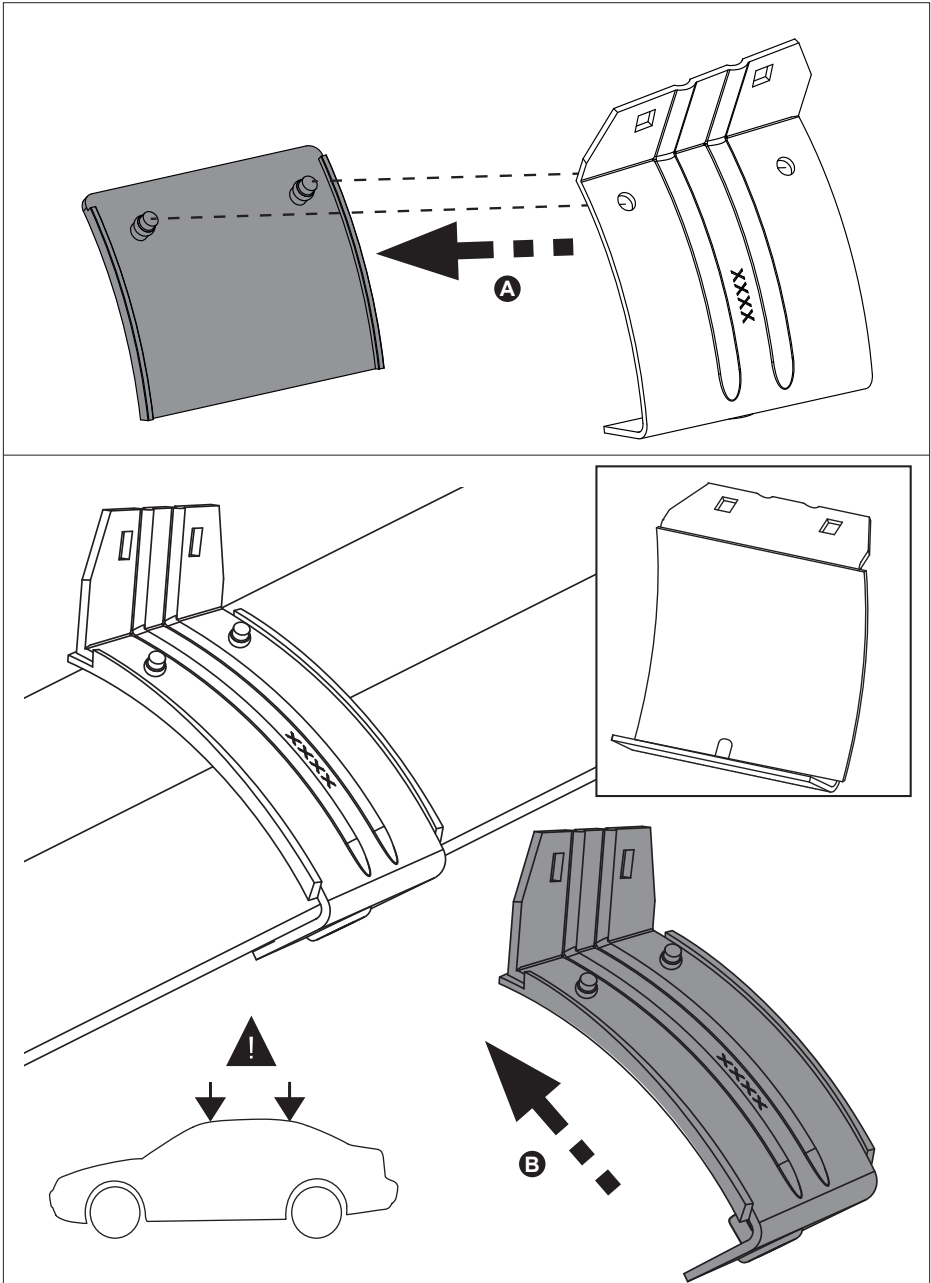

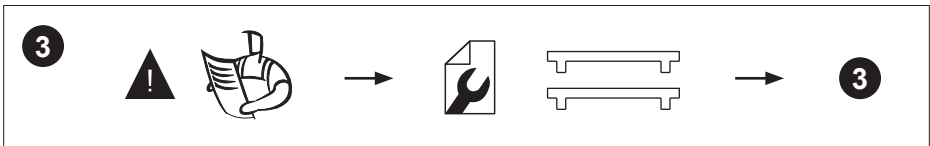
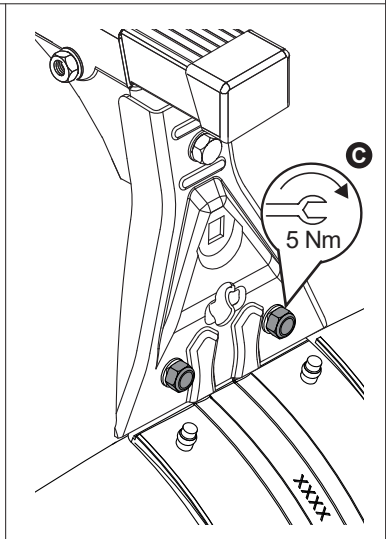
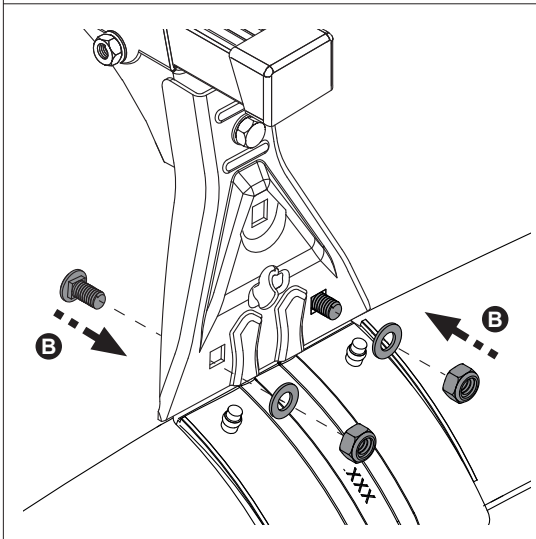
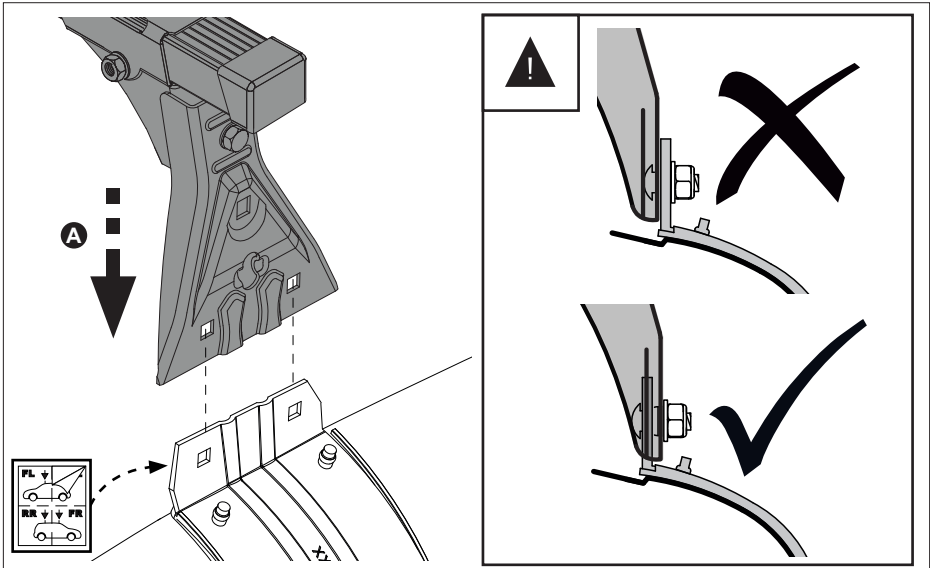





CRUZBER SA  
ES-A14018311  
Pol.Ind. Las Salinas II  
14960 - Rute - Spain

[www.firrak.com](http://www.firrak.com)